



Eighteen Sound  
an AEB S.r.l. Company

Via dell'Industria 20  
45025 Cavriago  
Italy

---

Application Note #5:

**Building an effective, high  
performance, two way,  
8" loudspeaker system**

Eighteen Sound Technical Department  
July, 2007



## 2 way 8" kit

- Two way loudspeaker system for high performance in a small and portable enclosure
- The 8MB400 woofer is combined with the ND1070 HF neo driver mounted on a XT120 horn to obtain a smooth frequency response, good directivity control and high power handling
- The passive crossover network design greatly simplifies the system setup
- ND1020 compression driver could be used as an alternative, cost effective choice



## 2 way 8" kit

### 8MB400



#### GENERAL SPECIFICATIONS

NOMINAL DIAMETER	200mm	(8 in)
RATED IMPEDANCE	8 ohms	
CONTINUOUS PINK NOISE (1)	280 W	
SENSITIVITY (2)	95 dB	
FREQUENCY RANGE (3)	55 ÷ 5200 Hz	
MAX RECOMM. FREQUENCY	3000 Hz	
RECOMM. ENCLOSURE VOLUME	10 ÷ 40 lt.	(0,35 ÷ 1,41 cuft)
VOICE COIL DIAMETER	51 mm	(2 in)
NET WEIGHT	3,6 kg	(7,95 lb)

#### THIELE-SMALL PARAMETERS (4)

Fs	64 Hz	
Re	5 ohms	
Sd	0,0227 sq.mt.	(35,19 sq.in.)
Qms	3,23	
Qes	0,43	
Qts	0,38	
Vas	23,9 lt.	(0,85 cuft)
Mms	18 gr.	(0,04 lb)
BL	9,3 Tm	
Linear Mathematical Xmax (5)	± 5,8 mm	(± 0,23 in)
Le (1kHz)	0,96 mH	
Ref. Efficiency		
1W @ 1m (half space)	93,7 dB	

### ND1020

### ND1070



#### GENERAL SPECIFICATIONS

THROAT DIAMETER	25,4 mm (1 in)	25,4 mm (1 in)
RATED IMPEDANCE	8 ohm	8 ohm
DC RESISTANCE	5,8 Ohm	5,3 Ohm
MINIMUM IMPEDANCE	6,5 Ohm at 5000Hz	7 Ohm at 4000Hz
LE (AT 1KHZ)	54 µH	67 µH
POWER HANDLING		
CONTINUOUS PINK NOISE (1)	30W above 2 kHz	50W above 1,6 kHz
CONTINUOUS PROGRAM (2)	60W above 2 kHz	100W above 1,6 kHz
SENSITIVITY(1W@1M) (3)	108,5 dB	109 dB
FREQUENCY RANGE	1600Hz ÷ 20kHz	1600Hz ÷ 20kHz
RECOMM. XOVER FREQUENCY	1600 Hz	1600Hz (12dB/oct slope)
DIAPHRAGM MATERIAL	Polyethylene	Pure Titanium dome
VOICE COIL DIAMETER	34,4 mm (1 1/3 in)	44,4mm (1 3/4 in)
VOICE COIL WINDING MATERIAL	Edge-wound aluminum	Edge-wound aluminum
MAGNET MATERIAL	Neodymium	Neodymium
FLUX DENSITY	1,8 T	1,8 T
BL FACTOR	6 N/A	8,2 N/A

### XT120



#### GENERAL SPECIFICATIONS

THROAT DIAMETER	25,4 mm	(1 in)
HORIZONTAL COVERAGE(+6dB)	90° (+1, -10) average range (2KHz ÷ 12,5KHz)	
VERTICAL COVERAGE (+6 dB)	60° (+15, -10) average range (2KHz ÷ 12,5KHz)	
DIRECTIVITY INDEX	15 dB (+2,5 ÷ 1,5) average range (2KHz ÷ 12,5KHz)	
USABLE FREQUENCY RANGE	Above 1,5 KHz	
RECOMM. CROSS.FREQUENCY	2 KHz or more	
SENSITIVITY (ON AXIS) (1)	108 dB	
FREQUENCY RANGE	2KHz ÷ 18KHz	

#### MOUNTING INFORMATION

OVERALL DIMENSIONS		
MOUTH HEIGHT	150 mm	(5,9 in)
MOUTH WIDTH	200 mm	(7,8 in)
DEPHT	103 mm	(4,1 in)
MOUTH MOUNTING DIMENSIONS		
	4 ø6 holes on the edge of rectangle with 165 mm x 115 mm (6,5 x 4,53 in) sides	
REAR HEIGHT	128 mm	(5 in)
REAR WIDTH	170 mm	(6,7 in)
NET WEIGHT	350 g	(0,75 lb)

- The enclosure should be made of baltic birch plywood (15mm thickness)
- The vents are from PVC plumbing connections
- Bolts are M5x35mm
- M5 T-Nuts are recommended
- Handling, rigging and connectors are user's choice
- It's recommended to well damping the cabinet interior
- An example of the optimal damping material disposition is shown in the bottom right image
- An high density dampening material, such as Dacron or other synthetic fibers, is required for best acoustic performance

### Internal view and damping

---

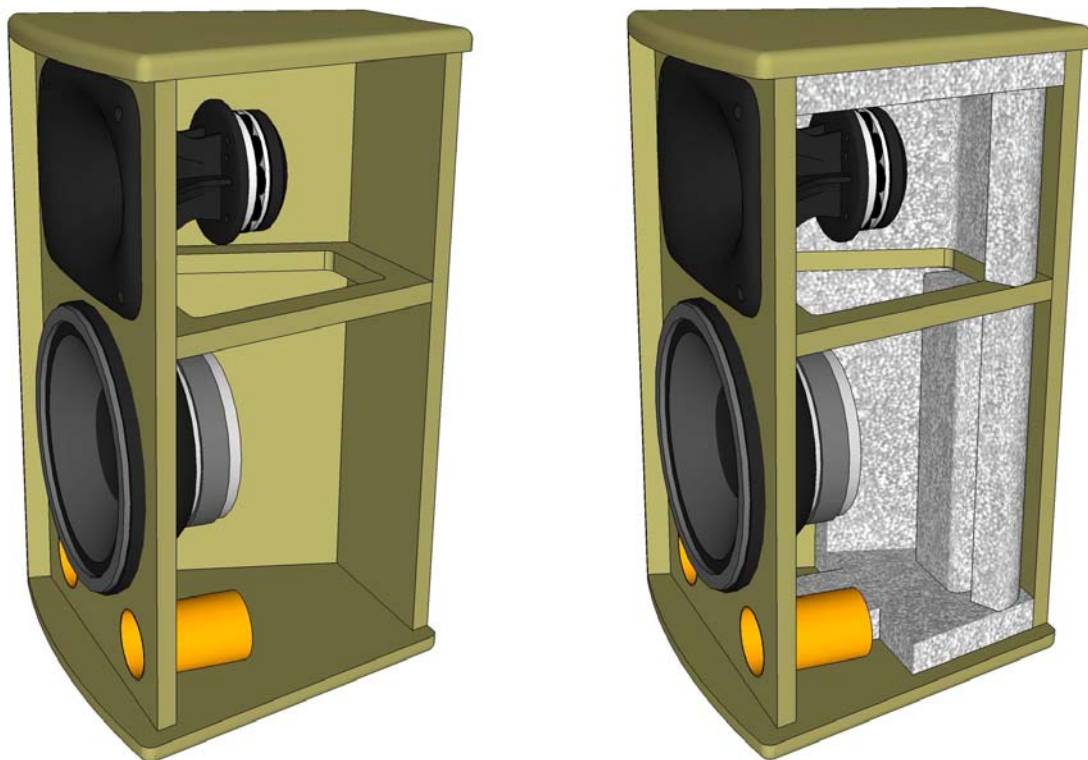

Exploded view



## 2 way 8" kit

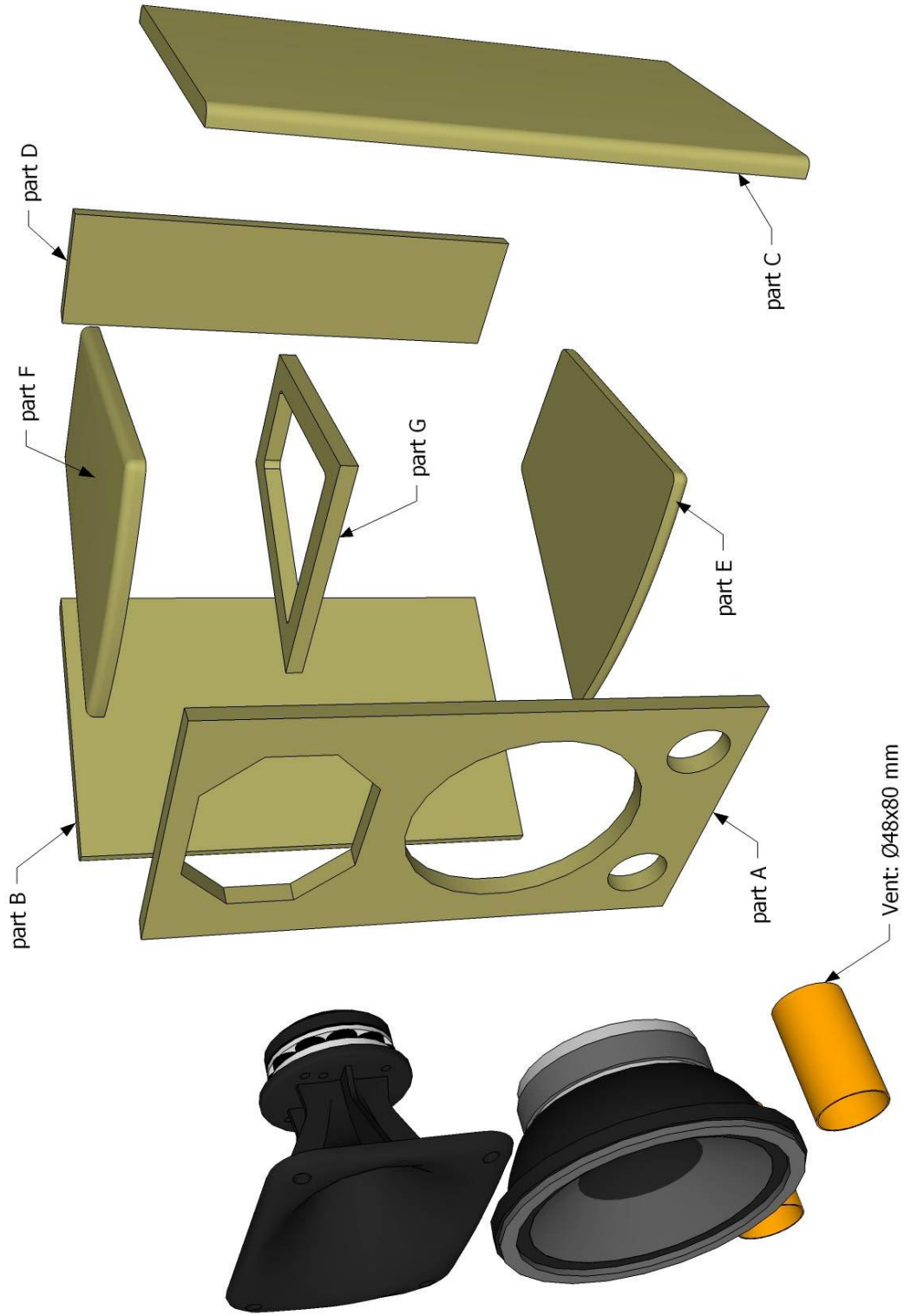

## Front view

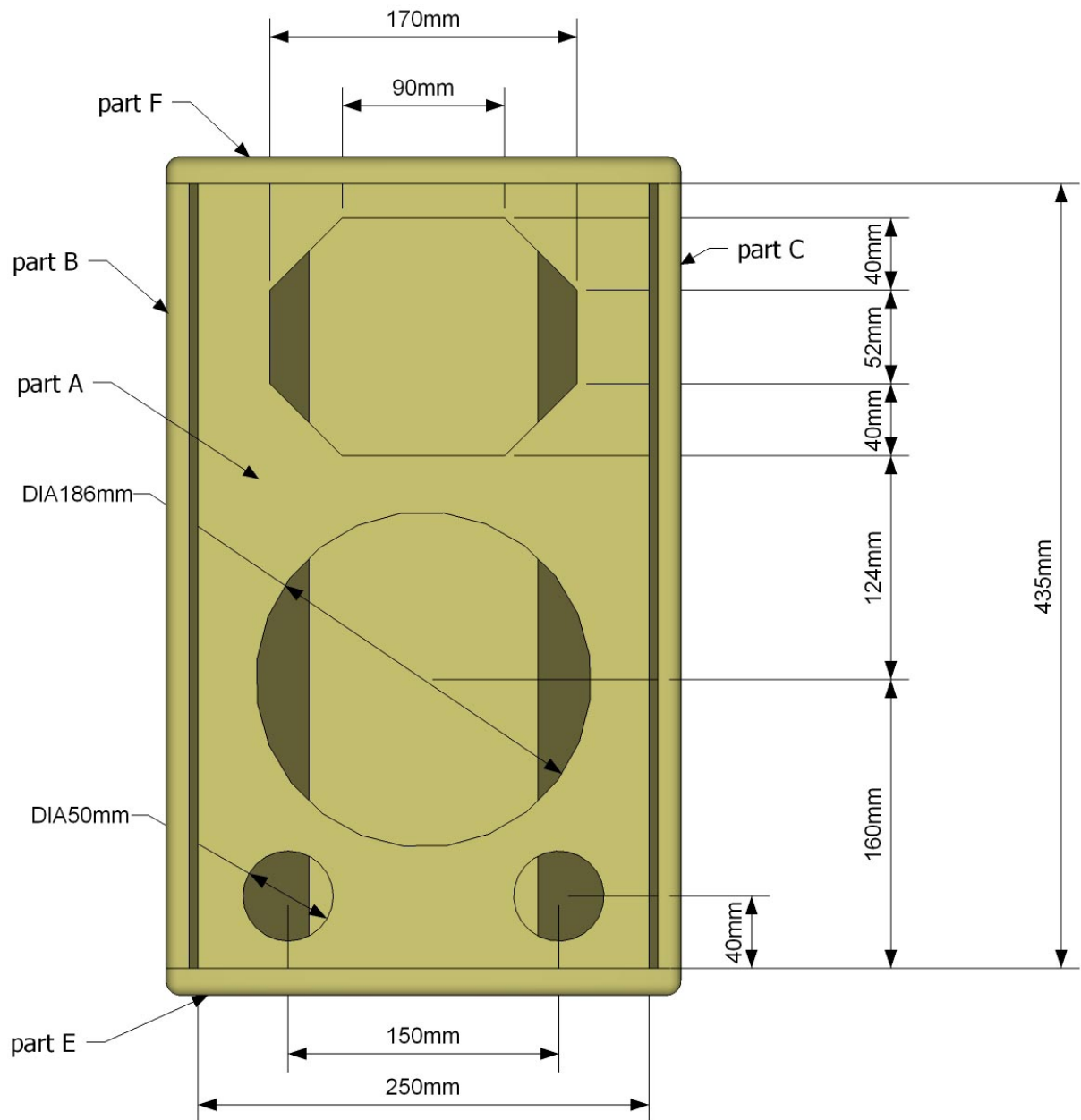



Front panel: bolts holes

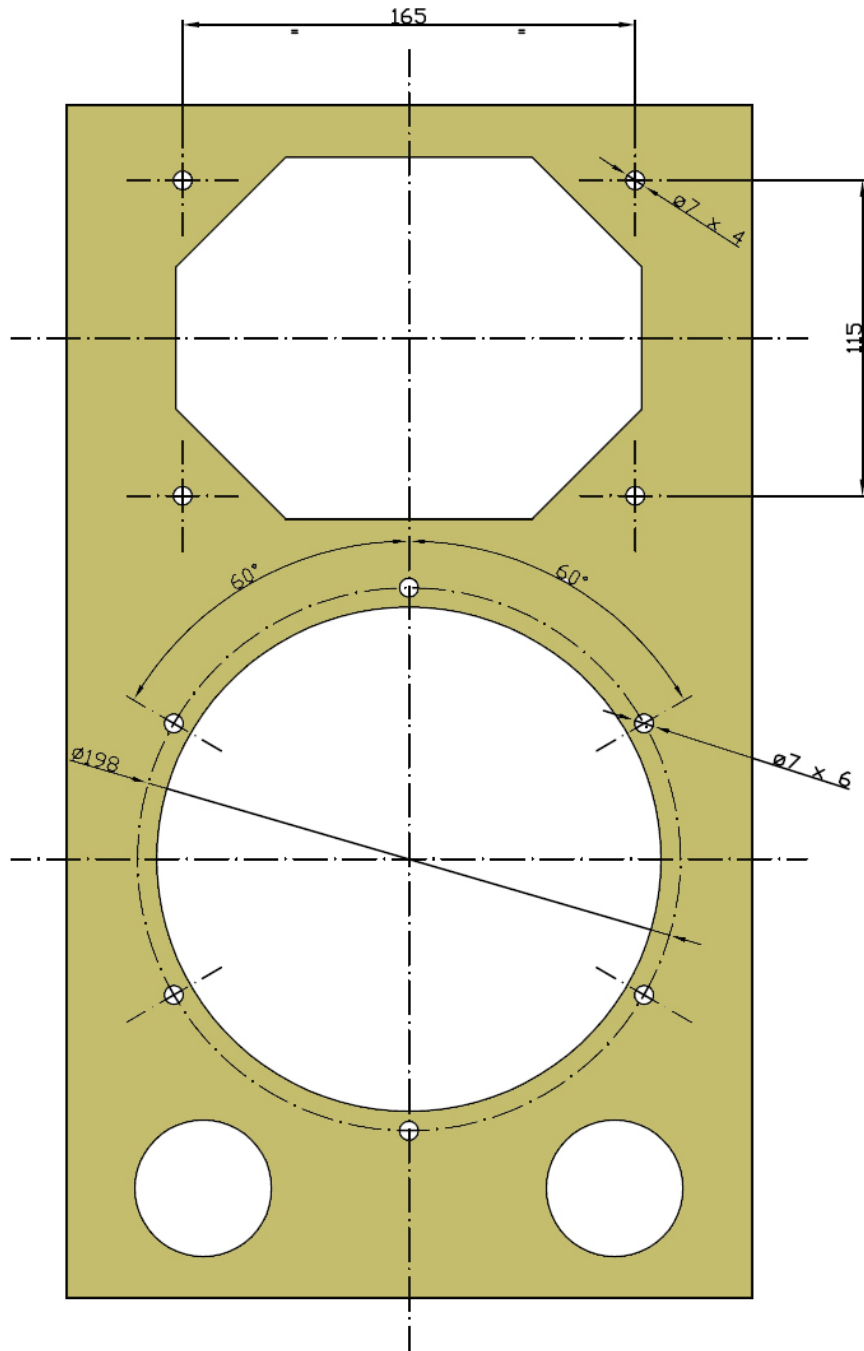

## Side view

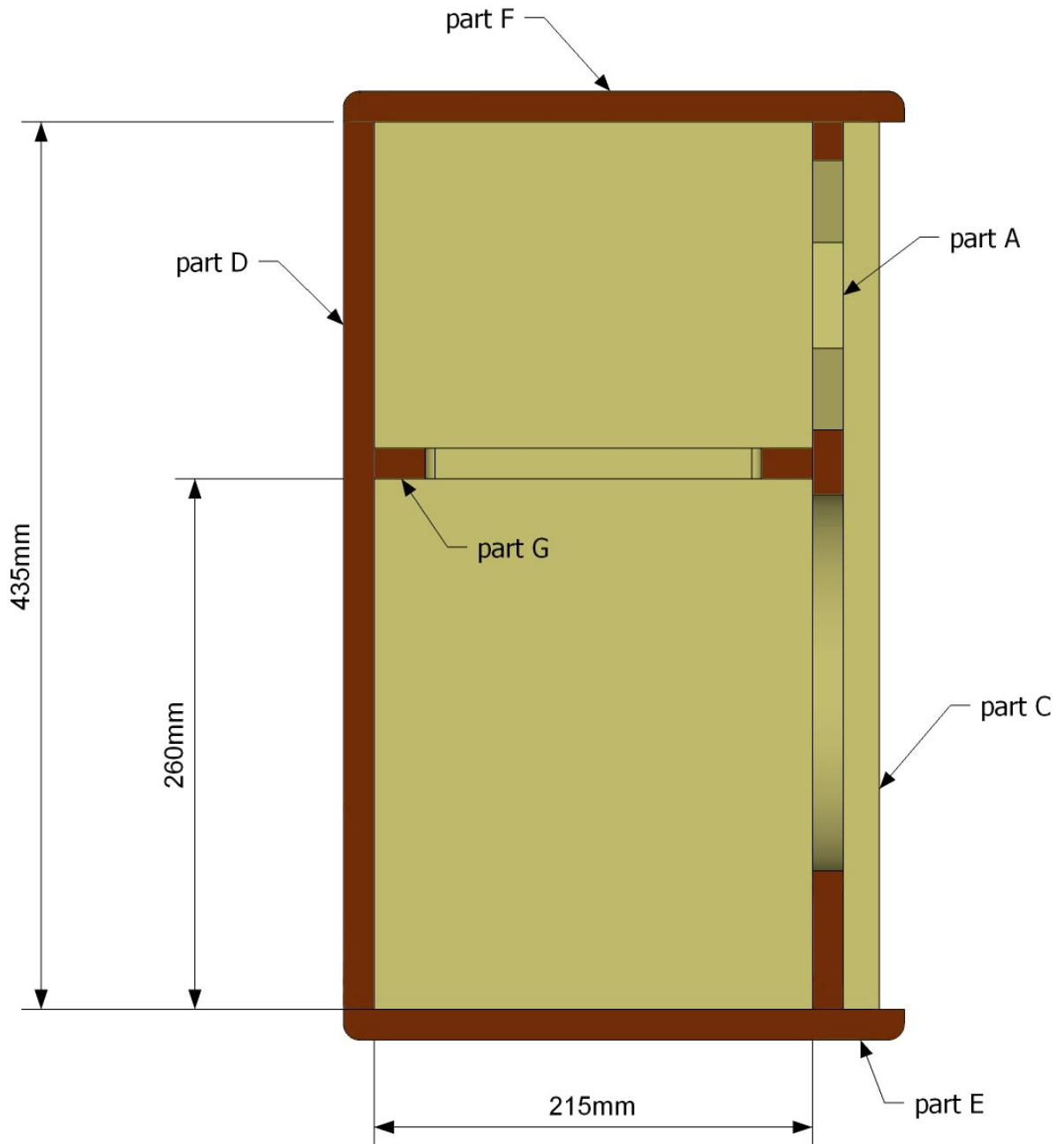



**Top-bottom view**

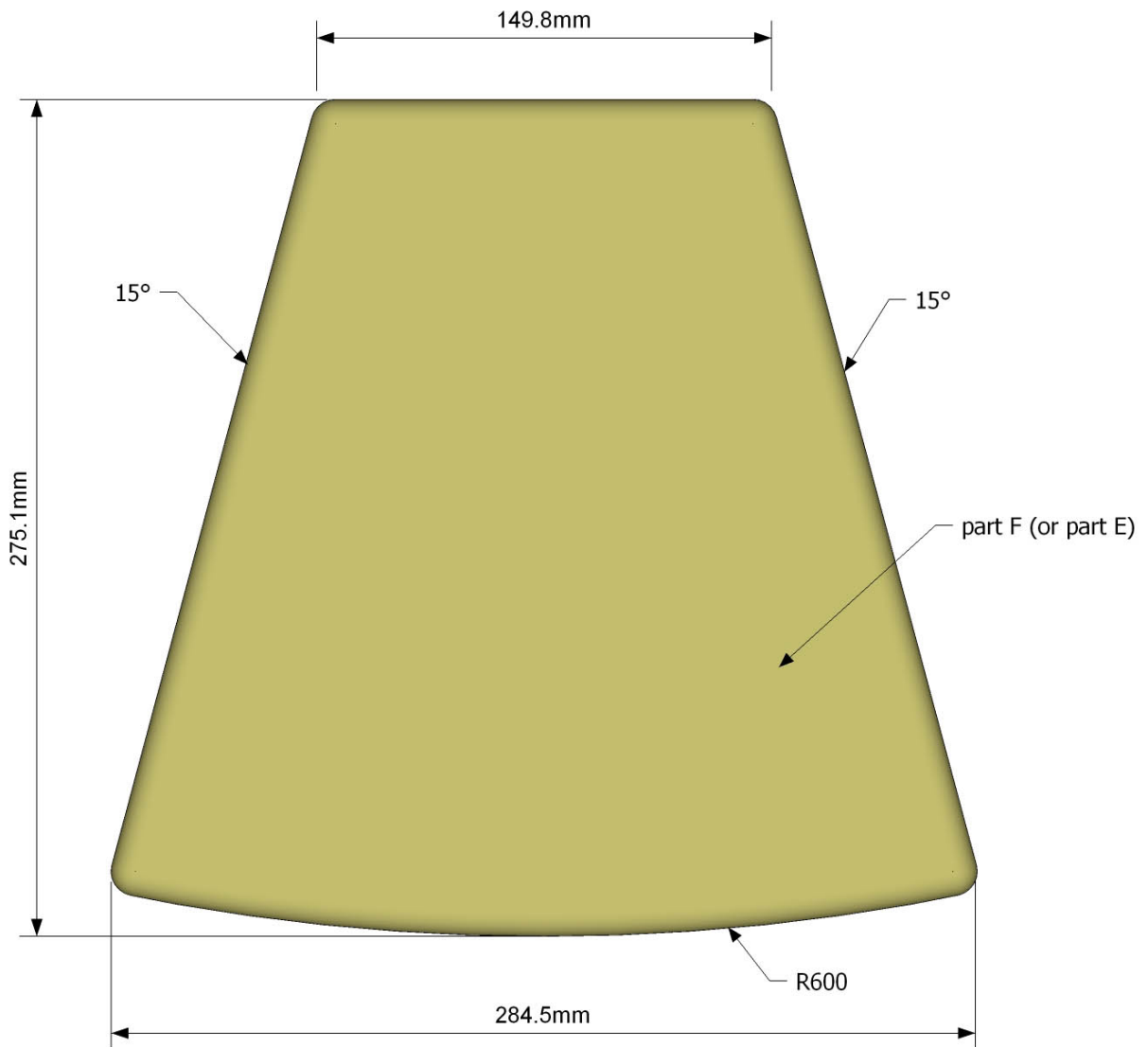

**Top view section**

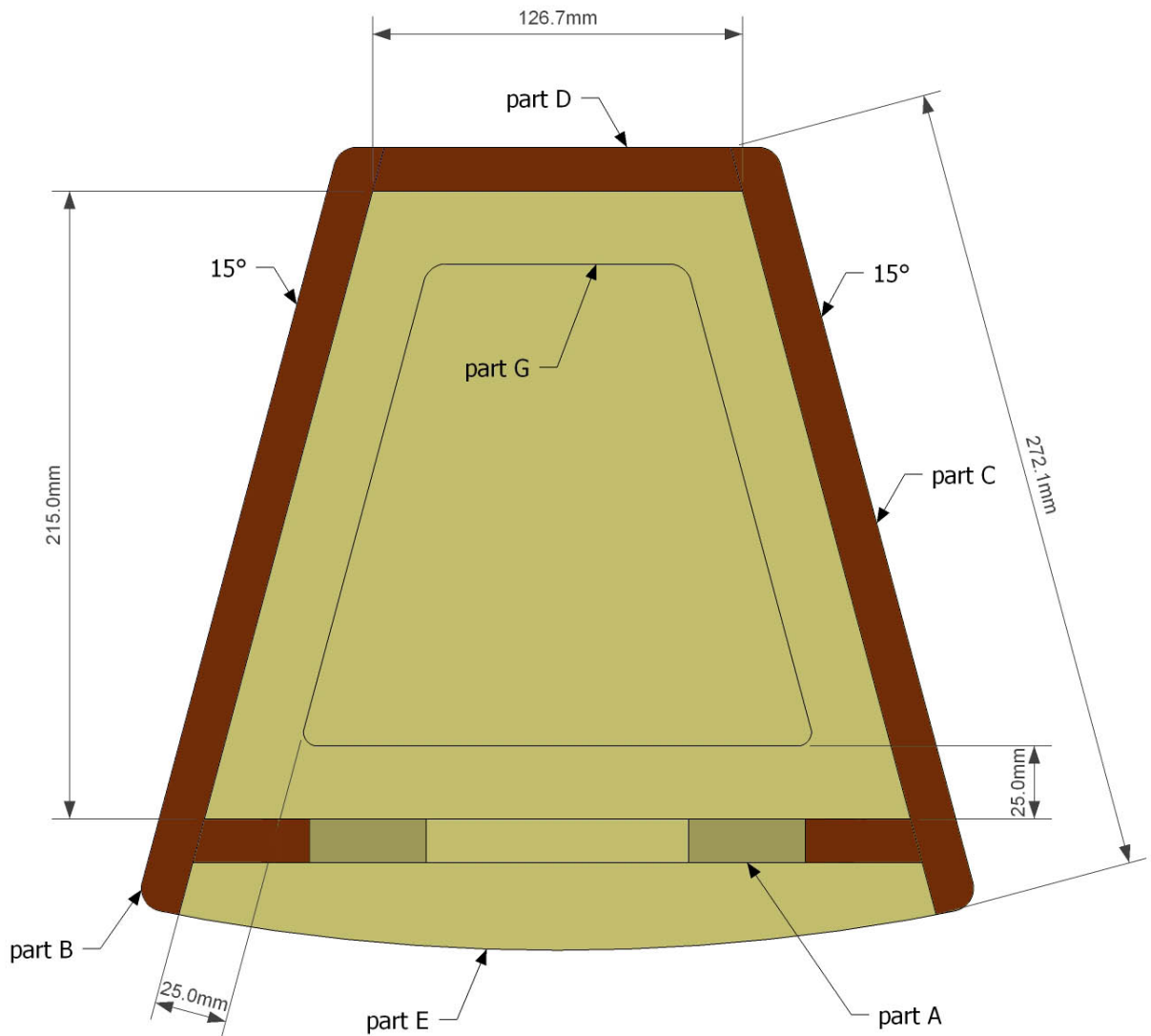

Horn height section



## 2 way 8" kit

---

Back view

---

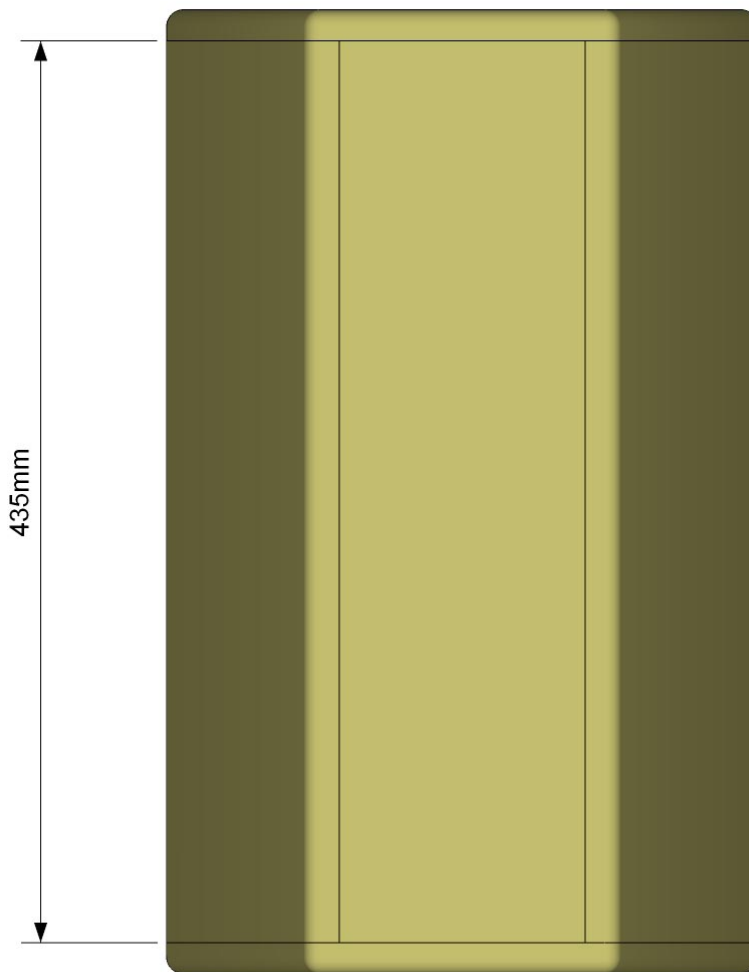

## Crossover schematics

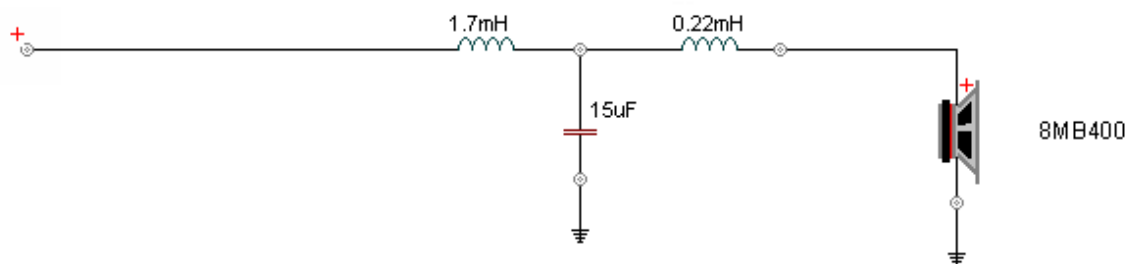
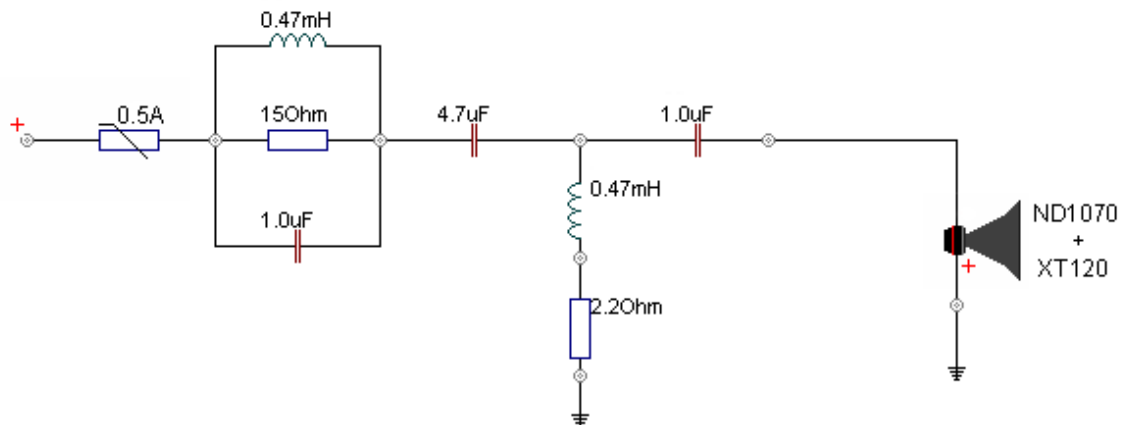

Components list		
Type	Value	Note
Inductor	0.47mH	<0.4 Ohm
Resistor	15 Ohm	> 10 W
Capacitor	1 uF	5% ->250V
Capacitor	4.7 uF	5% ->250V
Inductor	0.47 mH	<0.4 Ohm
Resistor	2.2 Ohm	> 10 W
Capacitor	1 uF	5% ->250V
Inductor	1.7 mH	<1 Ohm
Capacitor	15 uF	5% ->250V
Inductor	0.22 mH	<0.4 Ohm
PTC	0.5 A	



# 2 way 8" kit

## Measurements: 8MB400 + ND1070/XT120

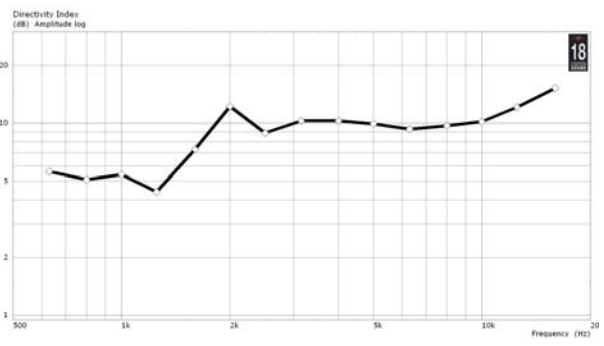
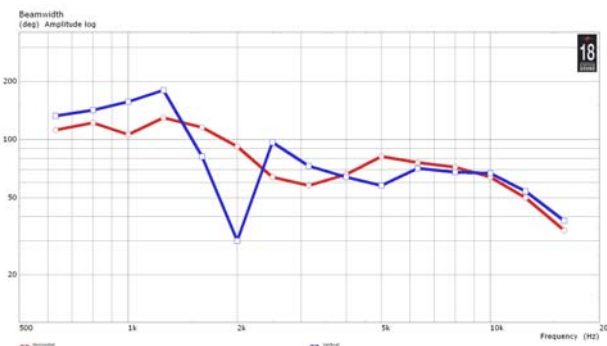
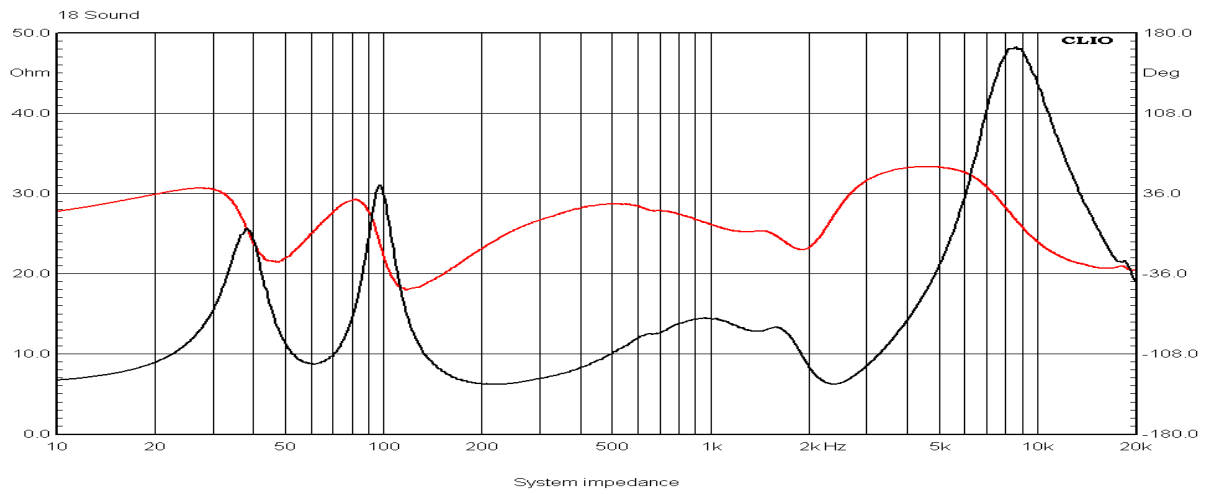
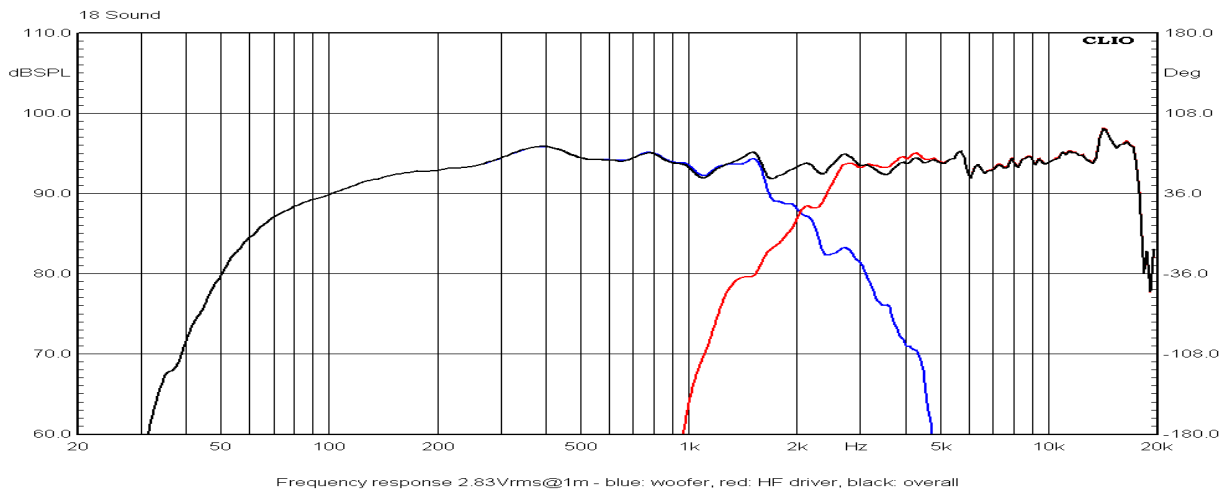

## Horizontal polar response

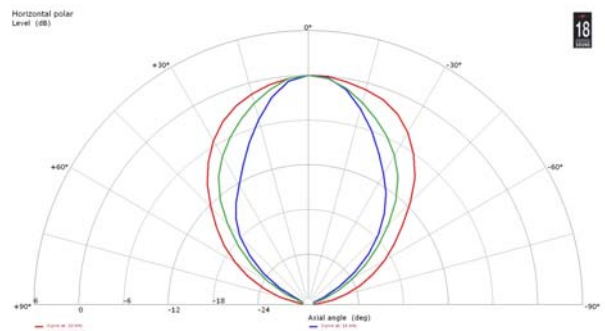
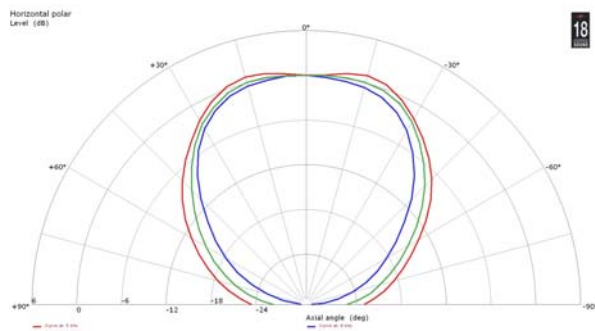
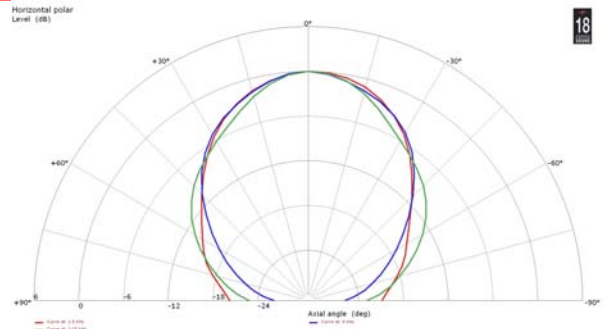
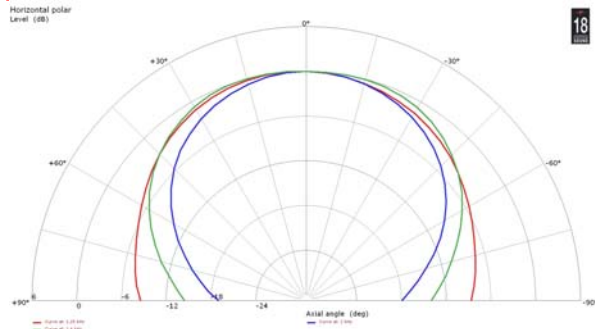

## Vertical polar response

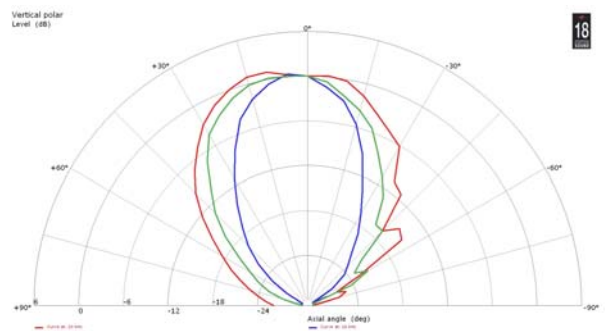
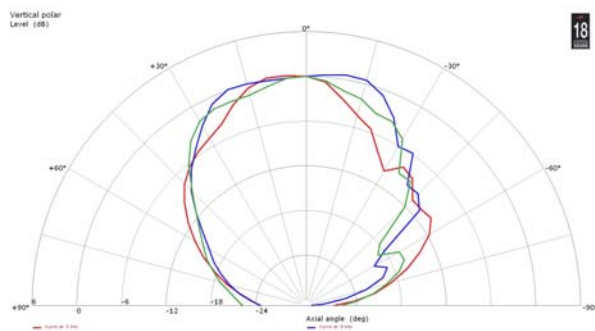
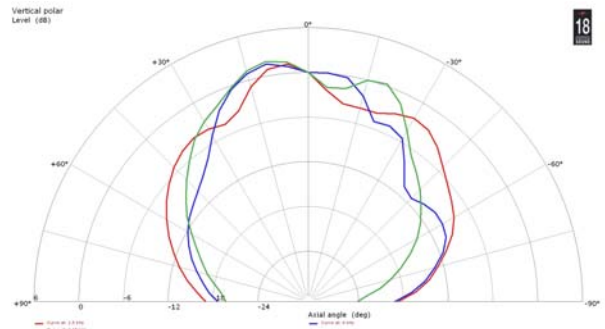
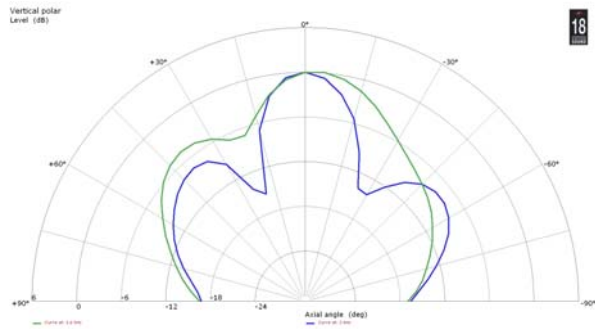



# 2 way 8" kit

## Horizontal polar map

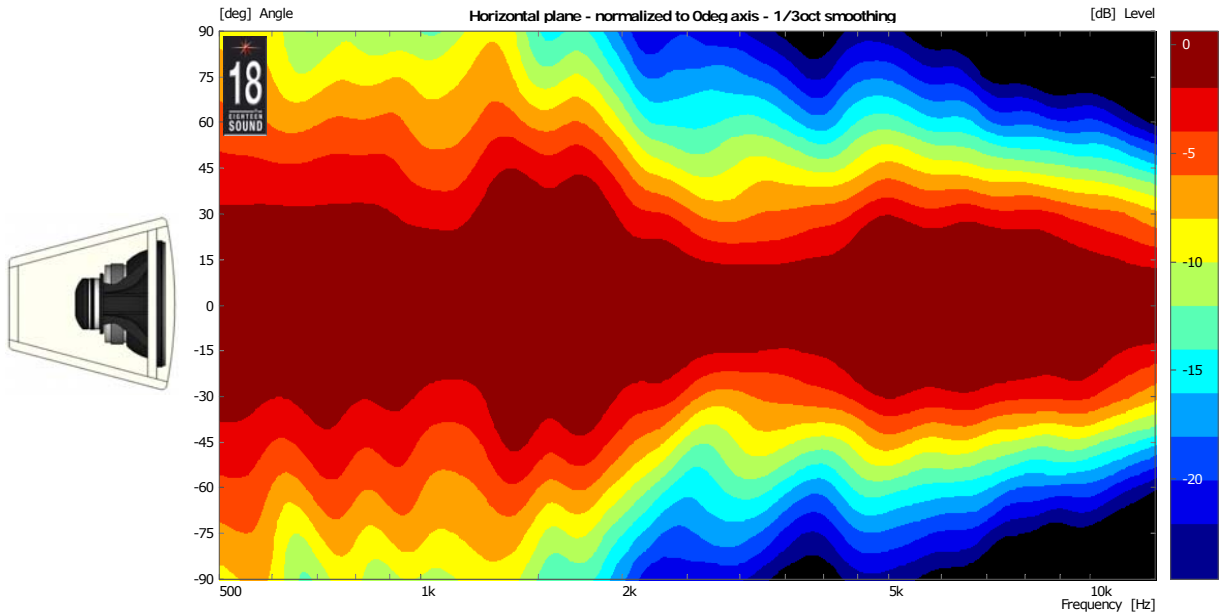

## Vertical polar map

